

CLARKE®



50L AIR COMPRESSOR

MODEL NO: RANGER 8/50

PART NO: 2242025

OPERATION & MAINTENANCE INSTRUCTIONS

UK
CA | CE



ORIGINAL INSTRUCTIONS

GC0324 - ISS 5

INTRODUCTION

Thank you for purchasing this CLARKE 50L Air Compressor.

Read this manual fully before use and follow the instructions carefully. In doing so you will ensure the safety of yourself and those around you and you can look forward to your purchase giving you long and satisfactory service.

GUARANTEE

This product is guaranteed against faulty manufacture for a period of 12 months from the date of purchase. Please keep your receipt which will be required as proof of purchase.

This guarantee is invalid if the product is found to have been abused or tampered with in any way, or not used for the purpose for which it was intended.

Faulty goods should be returned to their place of purchase, no product can be returned to us without prior permission.

This guarantee does not effect your statutory rights.

ENVIRONMENTAL RECYCLING POLICY



Through purchase of this product, the customer is taking on the obligation to deal with the WEEE in accordance with the WEEE regulations in relation to the treatment, recycling & recovery and environmentally sound disposal of the WEEE.

In effect, this means that this product must not be disposed of with general household waste. It must be disposed of according to the laws governing Waste Electrical and Electronic Equipment (WEEE) at a recognised disposal facility.





SAFETY PRECAUTIONS

Before using your compressor it is in your own interest to read and pay attention to the following safety rules.

1. Compressed air is dangerous. Do not point a jet of air at persons or animals and do not discharge compressed air against the skin.
2. DO NOT operate your compressor with the guard removed.
3. Repairs must only be carried out by a qualified engineer. If problems occur, contact your nearest Clarke dealer.
4. Before carrying out any maintenance, make sure that the pressure is released from the air tank and that the compressor is disconnected from the electrical supply.
5. DO NOT leave pressure in the receiver overnight, or when transporting.
6. DO NOT adjust or tamper with the safety valves. The maximum pressure is factory set, and clearly marked on the compressor.
7. DO NOT operate in wet or damp conditions. Keep the compressor dry at all times. Similarly, clean air will allow the compressor to work efficiently. Do not use in dusty or otherwise dirty locations.
8. Some of the metal parts can become quite hot during operation. Do not touch these until the compressor has cooled down.
9. Always set the pressure regulator to the recommended setting for the tool.
10. When spraying flammable materials e.g. cellulose paint, ensure that there is sufficient airflow and keep clear of any source of ignition.
11. Before spraying any material always consult paint manufacturers instructions for safety and usage.
12. Protect yourself. Goggles will protect your eyes from flying particles. Face masks will protect you against paint spray and fumes.
13. DO NOT apply strain to electrical cables and make sure that air hoses are not kinked or wrapped around the compressor.
14. When disconnecting air hoses or other equipment from your compressor, make sure that the air supply is turned off at the outlet and vent all pressurised air from within the tank and other equipment attached to it.
15. Make sure that children and animals are kept well away from the compressor and any equipment attached to it.
16. Make sure that all individuals using the compressor have had the necessary training and have read and fully understand these operating instructions.

17. Make sure that any equipment or tool used in conjunction with your compressor has a safe working pressure exceeding that of the compressor.
18. Be careful when transporting the compressor to prevent tipping over
19. Permanently installed systems must be installed by a competent engineer.
20. These compressors produce noise levels in excess of 70dB(A). Persons working near the compressor must be supplied with ear protection.

SAFETY SYMBOLS

	<p>Read this instruction booklet carefully before positioning, operating or adjusting the compressor.</p>
	<p>This compressor contains surfaces which may reach a high temperature during operation. Never operate with the motor housing removed.</p>
	<p>Wear safety goggles when using this compressor</p>
	<p>Wear ear protectors when using this compressor</p>
 96dB	<p>This compressor produces a high sound level during operation. Ear protection should be worn.</p>

ELECTRICAL CONNECTIONS



WARNING: READ THESE ELECTRICAL SAFETY INSTRUCTIONS THOROUGHLY BEFORE CONNECTING THE PRODUCT TO THE MAINS SUPPLY.

Connect the mains lead to a standard, 230 Volt (50Hz) electrical supply through an approved 13 amp BS 1363 plug, or a suitably fused isolator switch.

If the plug has to be changed because it is not suitable for your socket, or because of damage, it must be removed and a replacement fitted, following the wiring instructions shown below. The old plug must be discarded safely, as insertion into a power socket could cause an electrical hazard.



**WARNING: THE WIRES IN THE POWER CABLE OF THIS PRODUCT ARE COLOURED IN ACCORDANCE WITH THE FOLLOWING CODE:
BLUE = NEUTRAL BROWN = LIVE YELLOW AND GREEN = EARTH**

If the colours of the wires in the power cable do not agree with the markings on the plug:

- The BLUE wire must be connected to the terminal marked N or coloured black.
- The BROWN wire must be connected to the terminal marked L or coloured red.
- The YELLOW AND GREEN wire must be connected to the terminal marked E or  or coloured green.

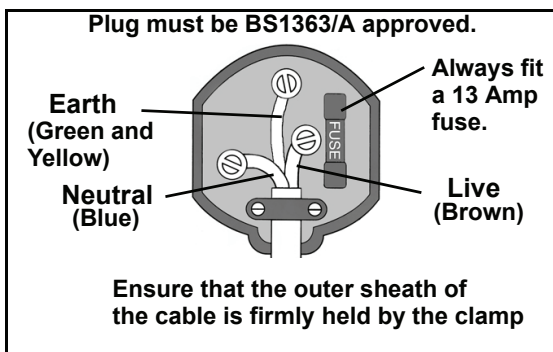

We strongly recommend that this machine is connected to the mains supply through a Residual Current Device (RCD)

If you are not sure, consult a qualified electrician. DO NOT try to do any repairs.

ASSEMBLY

ATTACH THE WHEELS

Use a spanner to attach the wheels to the compressor.

Use the washers and spring washer in the positions shown.

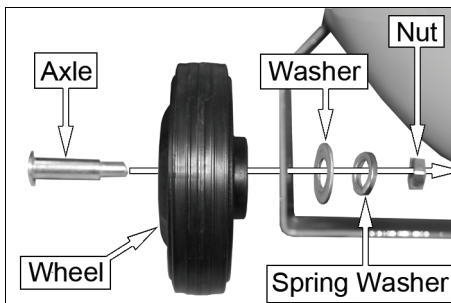

ATTACH THE FEET

Insert the feet into the position shown.

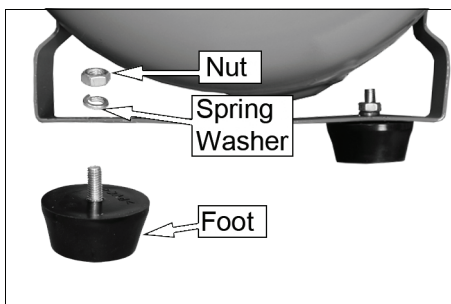

ATTACH THE AIR FILTER

1. Screw the air filter into position.
 - The air filter must be hand tight only.

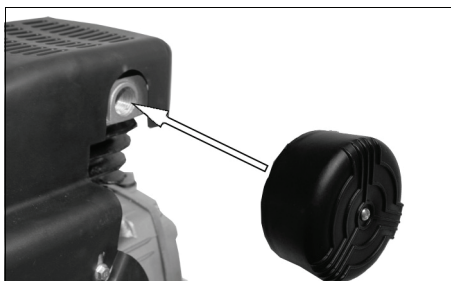

INSTALL THE OIL FILLER CAP

1. Remove the travel plug.

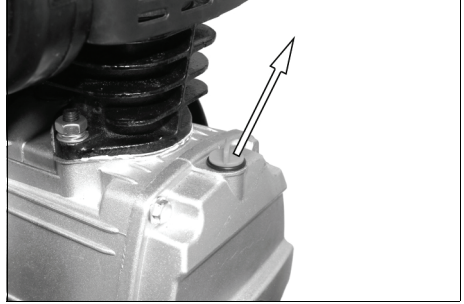

2. Insert the oil breather cap.

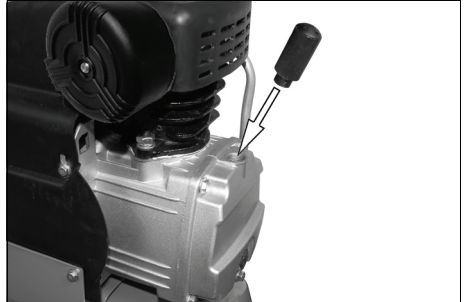

MOVING THE AIR COMPRESSOR



CAUTION: THE COMPRESSOR IS HEAVY AND REQUIRES TWO PEOPLE TO LIFT SAFELY.

- Stop the compressor and disconnect it from the power supply before you move it.
- Always use the handle.
- To prevent damage, do not lift by (or put strain on) valves or hoses.

BEFORE USE

Before you connect your compressor to the power supply, check the following:-

- Set the ON/OFF switch to the OFF position (pushed down).
- Make sure that the compressor is on level ground.
- Make sure that the supply voltage matches the voltage shown on the data label.



CHECK THE OIL LEVEL

1. Make sure that the oil level is half way up the oil sight glass.

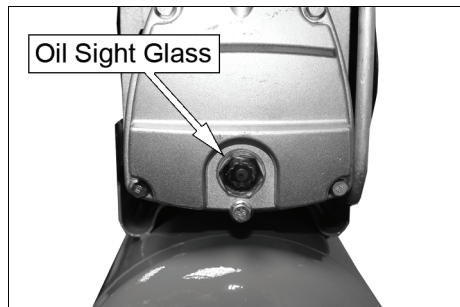

2. If not, remove the oil cap and add oil to the tank.
 - Only use SAE30 compressor oil, available from your Clarke dealer.
 - Only fill to the half way point on the sight glass, Overfilling may result in damage.

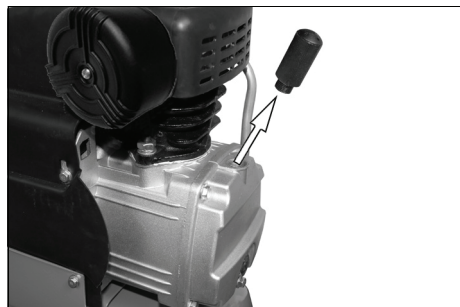

OPERATION

If the compressor has not been used for more than 24 hours, open the drain valve on the bottom of the tank and drain any condensate which has collected. See page 11.

ATTACHING AIR TOOLS



WARNING: BEFORE CONNECTING AIR TOOLS, MAKE SURE THAT YOU READ THE INSTRUCTIONS SUPPLIED WITH THE TOOL, ALSO ENSURE THAT THE TOOL IS SUITABLE FOR USE WITH THE COMPRESSOR AND HOSE SPECIFICATIONS.

1. Attach the air hose to one of the 1/4" BSP outlet valves.
2. Attach the tool to the end of the air hose.

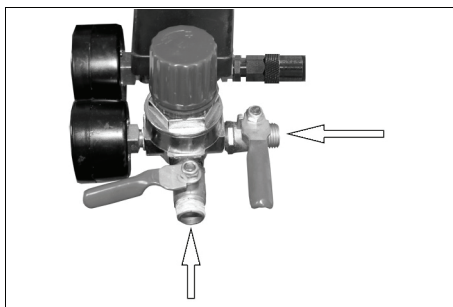

3. Turn the outlet valve handle to the open position.

NOTE: The outlet valve is shown without the air hose attached for clarity.

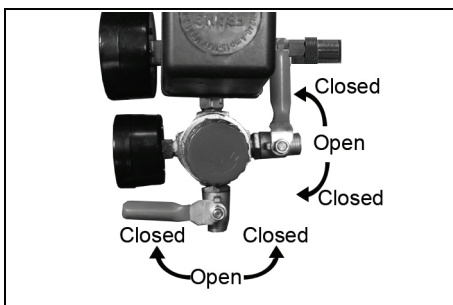

TURNING THE COMPRESSOR ON

1. Connect the compressor to the power supply.
2. Lift the On/Off button.
 - The compressor will operate until the tank is fully pressurised. It will then stop.
 - The compressor will start up again when the pressure in the tank decreases below a pre-set value.

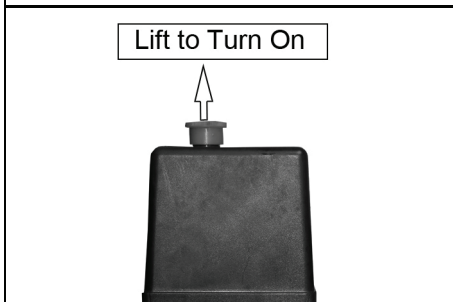

SET THE OUTPUT PRESSURE

1. Use the pressure regulator to set the output pressure of the outlet valves.
 - Turn clockwise to increase the pressure.
 - Turn counterclockwise to decrease the pressure.

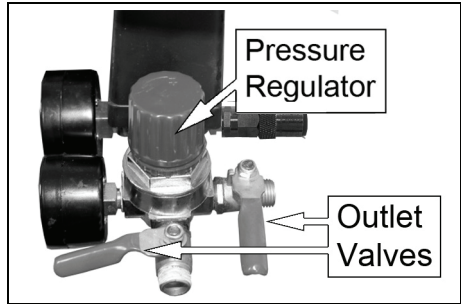

GAUGES

1. The tank pressure gauge shows the current pressure in the tank.
2. The outlet pressure gauge shows the 'user set' outlet pressure. This can be adjusted as shown above.

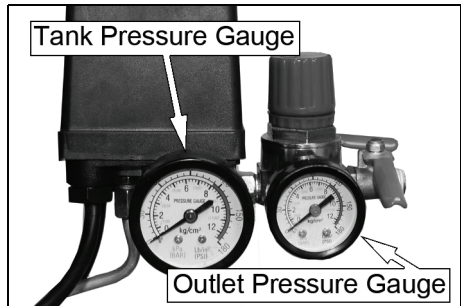

REMOVE TOOLS FROM THE AIR HOSE



WARNING: ALWAYS SET THE PRESSURE REGULATOR TO ZERO BEFORE YOU REMOVE OR REPLACE A TOOL.

1. Push down on the On/Off button to stop the compressor.



2. Turn the outlet valve handle to the closed position.
3. Operate the tool to depressurise the air hose.
4. Disconnect the tool from the hose.

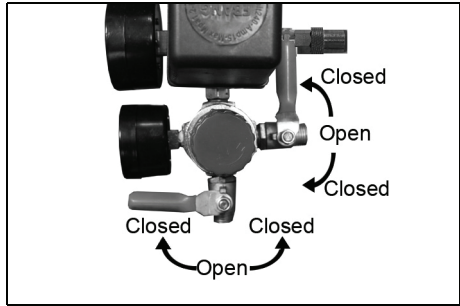

TURN THE COMPRESSOR OFF

1. Follow steps 1-3 above.
2. Disconnect the compressor from the power supply.
3. Slowly open one of the outlet valves to depressurise the tank.
 - You will hear a hissing sound as the tank depressurises.
 - Do not leave the compressor unattended if the tank is pressurised.

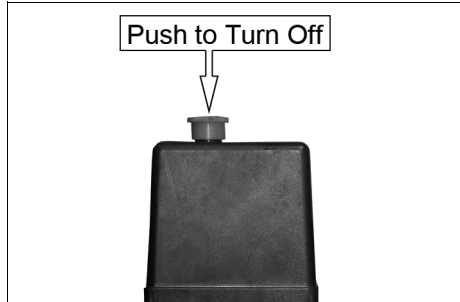

DRAINING THE TANK



CAUTION: YOU MUST DRAIN THE MOISTURE FROM THE TANK AFTER EACH DAYS USE AND BEFORE YOU PUT YOUR COMPRESSOR INTO STORAGE.

1. Turn the compressor off and disconnect it from the power supply.
2. Put a container below the drain valve to collect the condensate.
3. Slowly open one of the outlet valves to depressurise the tank.
 - You will hear a hissing sound as the tank depressurises.

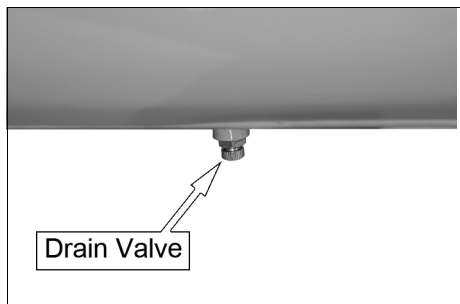

- Do not leave the compressor unattended if the tank is pressurised.
4. Open the drain valve slowly.
 - Condensation will drain from the tank.
 5. Close the drain valve when the tank has fully drained.

RESET BUTTON

This compressor has a thermal overload device.

If the motor gets too hot, the thermal overload device cuts the power which prevents damage to the motor.

If the thermal overload device operates, let the motor cool down for 5 minutes and push the reset button.

If you start the compressor and the overload cutout operates again, stop the compressor and disconnect from the power supply and have your compressor examined by a Clarke service agent.

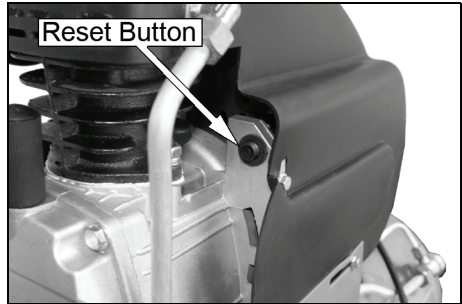

MAINTENANCE

CHECKING THE OIL LEVEL (DAILY)

1. Make sure that the oil level is half way up the oil sight glass.
2. If not, remove the oil breather cap and add oil to the reservoir.
 - Only use SAE30 compressor oil, available from your Clarke dealer.

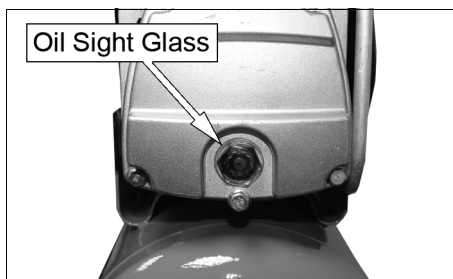

DRAIN THE TANK (DAILY)

After use, always open the drain valve to make sure that any condensate is drained off.

CLEAN THE AIR FILTER (MONTHLY)

The air filter must be examined monthly,- more often in dusty conditions,

1. Remove the filter cover from the filter.

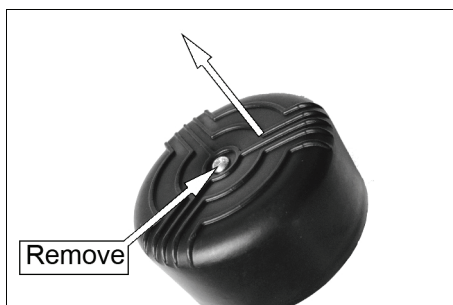

2. Remove the filter from the filter cover.
3. Use a soft brush to clean the sponge and the filter cover.
 - Clean the filter in warm soapy water if necessary.
 - Rinse and let the filter dry completely before refitting.
4. Make sure that the filter and filter cover are replaced into position.

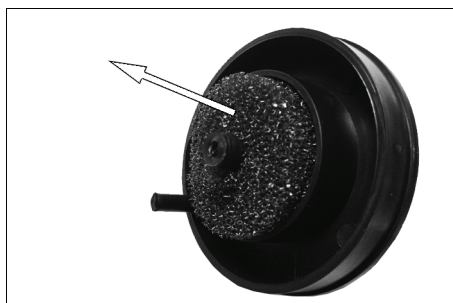

- If the filter is damaged you must replace it.

CHECK THE NON-RETURN VALVE (EVERY 6 MONTHS)

If the tank pressure decreases for no apparent reason, it is possible that the non-return valve is leaking. To check,

1. Make sure that the tank is not under pressure and the compressor is switched OFF.
2. Examine the non-return valve, and replace the gasket and valve if necessary.

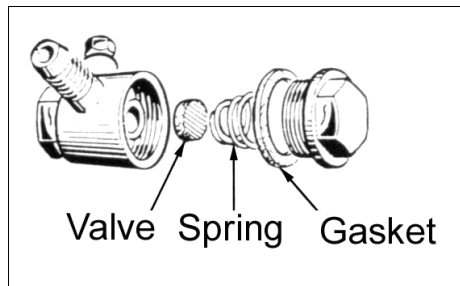
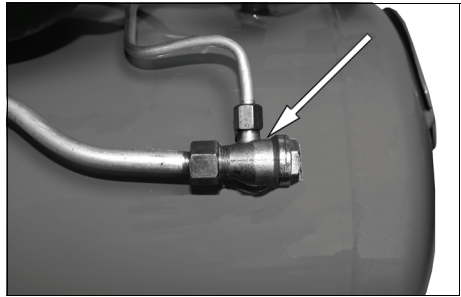

CHANGING THE OIL

1. Switch off the compressor and disconnect from the mains supply.
2. Release any air pressure in the hoses.
3. Hold a collection vessel under the oil drain plug.
4. Unscrew the oil drain plug from the compressor pump.
 - Collect the oil in the vessel.
 - If the oil does not drain out completely, we recommend tilting the compressor slightly.
5. When the oil has drained out, refit the oil drain plug.
6. Dispose of the old oil in an environmentally responsible way.

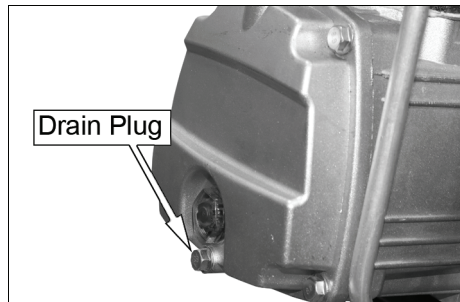

SPECIFICATIONS

Max Pressure	8 Bar / 116PSI
Voltage	230 VAC (50Hz)
Output Power	1491W
Air Displacement	7 CFM
Receiver Capacity	50 L
Fuse Rating	13 A
Dimensions (L x W x H)	725 x 380 x 650 mm
Guaranteed Sound Power Level	96 dB(A)
Weight	30 kg
Outlet Size	1/4" BSP
Oil Type	SAE30 Compressor Oil
Operating Temperature	5°C - 40°C

Please note that the details and specifications contained herein, are correct at the time of going to print. We reserve the right to change specifications at any time without prior notice.

TROUBLESHOOTING



CAUTION: DO NOT TRY TO REPAIR OR ADJUST THIS COMPRESSOR IF YOU ARE UNCERTAIN. IF YOU HAVE ANY QUERIES, CONTACT YOUR DEALER.

PROBLEM	PROBABLE CAUSE	REMEDY
The compressor has stopped and does not start.	Bad electrical connections.	<ol style="list-style-type: none"> 1. Check electrical connections. 2. Clean and tighten if necessary.
	Overload cutout switch has tripped.	<ol style="list-style-type: none"> 1. Switch off and wait approx 5 minutes. 2. Press the reset button and switch on again.
	Motor windings burnt out.	<ol style="list-style-type: none"> 1. Contact your Clarke dealer for a replacement motor.
Compressor does not reach the set pressure and overheats	Compressor head gasket blown or valve broken.	<ol style="list-style-type: none"> 1. Return the compressor to your nearest Clarke service agent.
Compressor does not start.	The tank has already fully pressurised.	<ol style="list-style-type: none"> 1. Open drain valve to expel air. Compressor should start again when pressure reduces.
Air leaking from the non-return valve when the compressor is not running.	Faulty non-return valve.	<ol style="list-style-type: none"> 1. Drain receiver completely of air. 2. Remove the valve end plug, 3. Carefully clean the valve seat and the gasket. 4. Reassemble.
Air pressure from the regulator will not adjust.	The diaphragm within the regulator body is broken.	<ol style="list-style-type: none"> 1. Replace regulator.
Compressor is noisy & makes a metallic knocking sound.	Compressor damaged and needs overhaul.	<ol style="list-style-type: none"> 1. Return the compressor to your nearest Clarke service agent.

PARTS DIAGRAM

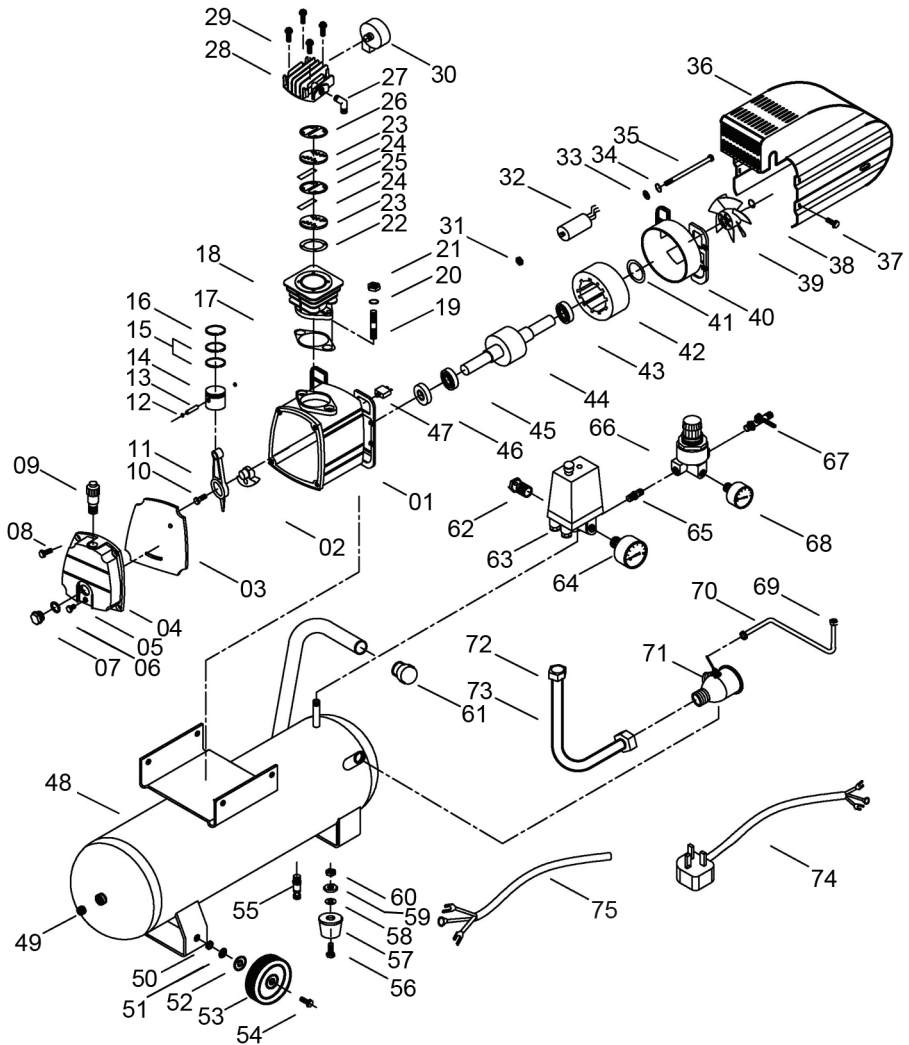

PARTS LIST

1	CRANKCASE
2	CRANKSHAFT
3	OILSEAL GASKET
4	FRONT COVER
5	OIL DRAIN PLUG
6	OIL SIGHTGLASS SEAL
7	OIL SIGHTGLASS
8	BOLT
9	BREATHER
10	SCREW
11	CONNECTING ROD
12	RETAINING RING
13	PISTON PIN
14	PISTON
15	OIL RING
16	COMPRESSION RING
17	CYLINDER GASKET
18	CYLINDER
19	STUD BOLT
20	SPRING WASHER
21	NUT
22	VALVE PLATE GASKET
23	VALVE PLATE
24	VALVE REED
25	ALUMINUM GASKET
26	CYLINDER HEAD GASKET
27	ELBOW
28	CYLINDER HEAD
29	HEX BOLT
30	AIR FILTER
31	NUT
32	CAPACITOR
33	FLAT WASHER
34	SPRING WASHER
35	LONG BOLT
36	SHROUD
37	BOLT
38	CIRCLIP

39	FAN
40	BEARING SEAT
41	WAVE GASKET
42	STATOR
43	BALL BEARING
44	ROTOR
45	BALL BEARING
46	OIL SEAL
47	OVERLOAD PROTECTOR
48	TANK
49	HOLE PLUG
50	NUT
51	SPRING WASHER
52	FLAT WASHER
53	WHEEL
54	BOLT
55	DRAIN VALVE
56	BOLT
57	FOOT
58	FLAT WASHER
59	SPRING WASHER
60	NUT
61	HANDLE PLUG
62	SAFETY VALVE
63	PRESSURE SWITCH
64	PRESSURE GAUGE (50 MM)
65	CONNECTOR
66	REGULATOR
67	BALL VALVE
68	PRESSURE GAUGE (40 MM)
69	NUT
70	TUBE
71	CHECK VALVE
72	NUT
73	EXHAUSTING PIPE
74	POWER CABLE
75	MOTOR CABLE

DECLARATIONS OF CONFORMITY



DECLARATION OF CONFORMITY

This is an important document and should be retained.

We hereby declare that this product(s) complies with the following legislation:

- The Electromagnetic Compatibility Regulations 2016
- The Supply of Machinery (Safety) Regulations 2008
- The Noise Emission in the Environment by Equipment for use Outdoors Regulations 2001
- The Pressure Equipment (Safety) Regulations 2016
- The Restriction of the Use of Certain Hazardous Substances in Electrical and Electronic Equipment Regulations 2012
- The Simple Pressure Vessels (Safety) Regulations 2016

The following standards have been applied to the product(s):

- EN 62321-4:2014+A1:2017, EN IEC 61000-6-1:2019, EN IEC 61000-6-3:2021, EN 62321-1:2013,
- EN 62321-7-1:2015, EN 62321-7-2:2017, EN 62321-5:2014, EN 62321-6:2015, EN 62321-8:2017,
- EN 62321-3-1:2014, EN ISO 3744:1995, EN 60204-1:2018, EN 62321-2:2014, EN 1012-1:2010,
- EN ISO 4126-1, EN 12516-1, EN 286-1

OUTDOOR NOISE	
Notified Body:	Ente Certificazione Macchine (ID: 1282), Via Cal Sella 243, Castello di Serravalle, 40053 Valmaggia (BO), Italy
Assessment Procedure:	Annex VI of above noise legislation
Measured LWA:	95.1 dB
Guaranteed LWA:	97 dB

PRESSURE EQUIPMENT	
Notified Body:	TUV Rheinland Bulgaria EOOD (ID: 1853), 36 Dragin Tsankov Boulevard, Block B, Floor 8, Office 801, 1040 Sofia, Bulgaria
Certificate Number:	1853-PED-20 0204
Assessment Category:	IV
Assessment Module(s):	B (Production Type)

SIMPLE PRESSURE VESSELS	
Notified Body:	TUV SUD Industrie Service GmbH (ID: 0036), Westendstraße 199, 80686 München, Germany
Certificate Number:	12 202 230591252 001-1
Assessment Category:	N/A
Assessment Module(s):	C2

This declaration is issued, in accordance with (UK) legislation, under the sole responsibility of the manufacturer. The technical documentation required to demonstrate that the product(s) meet(s) the requirement(s) of the aforementioned legislation has been compiled and is available for inspection by the relevant enforcement authorities.

The UKCA mark was first applied in: 2024

Manufacturer: Clarke International Ltd, Hernalld Street, Epping, Essex, CM16 4LG, United Kingdom

Product Description: Air Compressor

Model Number(s): RANGER 8-50

Serial/Batch Number: Refer to product/packaging label

Document Holder: Alan Pond

Date of Issue: 15/03/2024

Signed:

J.A. Clarke
Director

RANGER 8-50 UKCA DOC 031524

Page 1 of 1



DECLARATION OF CONFORMITY

This is an important document and should be retained.

We hereby declare that this product(s) complies with the following legislation:

- 2014/30/EU Electromagnetic Compatibility Directive
- 2006/42/EC Machinery Directive
- 2000/14/EC Outdoor Noise Directive
- 2014/68/EU Pressure Equipment Directive
- 2011/65/EU Restriction of Hazardous Substances (RoHS) Directive
- 2014/29/EU Simple Pressure Vessels Directive

The following standards have been applied to the product(s):

- EN 62321-4:2014+A1:2017, EN IEC 61000-6-1:2019, EN IEC 61000-6-3:2021, EN 62321-1:2013,
- EN 62321-7-1:2015, EN 62321-7-2:2017, EN 62321-5:2014, EN 62321-6:2015, EN 62321-8:2017,
- EN 62321-3-1:2014, EN ISO 3744:1995, EN 60204-1:2018, EN 62321-2:2014, EN 1012-1:2010,
- EN ISO 4126-1, EN 12516-1, EN 286-1

OUTDOOR NOISE	
Notified Body:	Ente Certificazione Macchine (ID: 1282), Via Cal Sella 243, Castello di Serravalle, 40053 Valmaggia (BO), Italy
Assessment Procedure:	Annex VI of above noise legislation
Measured LWA:	95.1 dB
Guaranteed LWA:	97 dB

PRESSURE EQUIPMENT	
Notified Body:	TUV Rheinland Bulgaria EOOD (ID: 1853), 36 Dragin Tsankov Boulevard, Block B, Floor 8, Office 801, 1040 Sofia, Bulgaria
Certificate Number:	1853-PED-20 0204
Assessment Category:	IV
Assessment Module(s):	B (Production Type)

SIMPLE PRESSURE VESSELS	
Notified Body:	TUV SUD Industrie Service GmbH (ID: 0036), Westendstraße 199, 80686 München, Germany
Certificate Number:	12 202 230591252 001-1
Assessment Category:	N/A
Assessment Module(s):	C2

This declaration is issued, in accordance with (EU) legislation, under the sole responsibility of the manufacturer. The technical documentation required to demonstrate that the product(s) meet(s) the requirement(s) of the aforementioned legislation has been compiled and is available for inspection by the relevant enforcement authorities.

The CE mark was first applied in: 2019

Manufacturer: Clarke International Ltd, Fitzwilliam Hall, Fitzwilliam Place, Dublin 2, Republic of Ireland

Product Description: Air Compressor

Model Number(s): RANGER 8-50

Serial/Batch Number: Refer to product/packaging label

Document Holder: Alan Pond

Date of Issue: 15/03/2024

Signed:

J.A. Clarke
Director

RANGER 8-50 CE Clarke DOC 031524

Page 1 of 1

A SELECTION FROM THE VAST RANGE OF

Clarke®

QUALITY PRODUCTS



AIR COMPRESSORS

From DIY to industrial, Plus air tools, spray guns and accessories.

GENERATORS

Prime duty or emergency standby for business, home and leisure.

POWER WASHERS

Hot and cold, electric and engine driven - we have what you need

WELDERS

Mig, Arc, Tig and Spot. From DIY to auto/industrial.

METALWORKING

Drills, grinders and saws for DIY and professional use.

WOODWORKING

Saws, sanders, lathes, mortisers and dust extraction.

HYDRAULICS

Cranes, body repair kits, transmission jacks for all types of workshop use.

WATER PUMPS

Submersible, electric and engine driven for DIY, agriculture and industry.

POWER TOOLS

Angle grinders, cordless drill sets, saws and sanders.

STARTERS/CHARGERS

All sizes for car and commercial use.

PARTS & SERVICE: 0208 988 7400

Parts Enquiries
Parts@clarkeinternational.com

Servicing & Technical Enquiries
Service@clarkeinternational.com

SALES: UK 01992 565333 or Export 00 44 (0)1992 565335

Clarke INTERNATIONAL Hemnall Street, Epping, Essex CM16 4LG
www.clarkeinternational.com